

GAZ[®]

Industrial Ni-Cd Batteries Standard Ranges
Ni-Cd Industriebatterien Standardbaureihen
KL ... P | KM ... P | KH ... P

Made in Germany



EnerSys[®]
Power/Full Solutions

SINGLE CELL CONSTRUCTION

Konstruktion der Einzelzellen

Gas drying or flame arresting vent

Gastrockner – oder flammenhemmender Stopfen

Safety terminal

Redundant leak protection minimizes carbonate formation.

Sicherheitspol

Zweifachdichtung minimiert Karbonatisierung.

Electrode edge

Connected to pole bolt by screwing or welding.

Elektrodenfahne

Mit Polbolzen verschraubt oder verschweißt. Stellt hohe mechanische Stabilität sicher.

Electrode frame

Consisting of electrode edge and side bars. Seals the plates and works as a current collector.

Elektrodenrahmen

Bestehend aus Elektrodenfahne und Seitenstegen. Verschließt die Platten und dient der Stromableitung.

Corrugated perforated plastic separator

Insulates the plates and allows free circulation of electrolyte.

Perforierter Wellenseparator

isoliert Platten und ermöglicht eine ungehinderte Zirkulation des Elektrolyten.

Horizontal pockets

Formed by perforated steel strips containing the active material.

Horizontale Taschenplatten

Perforiertes Stahlband umschließt die Aktivmasse

Distance plate

Prevents movement of the electrode pack.

Distanzplatte

fixiert den Plattenblock



Advantages of Ni-Cd batteries

- Very good high power rating
- Very good cycling capability
- Reduced maintenance costs – exceptional life cycle costs
- Low internal resistance
- No risk of sudden death or terminal runaway effect
- No electrolyte stratification
- No electrode plate corrosion or passivation
- Reduced loss of capacity at deep temperature
- No ice formation at temperatures below 0 °C
- Exceptional lifetime at high temperatures, 20 plus years in stationary cycling applications
- Insensitive against deep discharge
- Operational temperature range between – 40 °C to + 50 °C
- Long shelf life of several years in a discharged state under correct conditions
- Robust construction – insensitive against faulty maintenance
- Large electrolyte reserve - reduced maintenance costs

GAZ® Ni-Cd Batteries

GAZ® Ni-Cd cells and batteries with pocket plate electrodes have a proven design and reliability to give maximum service life. With more than 100 years of experience in the design, manufacturing and continuously improving and further developments in techniques will provide maximum performance and security independent of the mains electricity supply. Its outstanding features make the GAZ® Ni-Cd battery range one of the most reliable and adequate systems available in the market. It is a long effecting durable and safe solution. GAZ® prides itself on the high standards of quality for which it is renewed.

GAZ® Ni-Cd battery cells fulfil all requirements according to IEC 60623 and EN 60623.

Configuration forms

GAZ® Ni-Cd cells can be assembled into many different configurations, for example:

- Placing on battery racks and cabinets
- Mounting as compact blocks
- Assembling in plastic/ stainless steel crates or battery troughs

Fields of application

UPS, railway, power and substations, renewable energy stations, ship equipment, telecommunications

Quality Management System

The Quality Management System of our company has been certified since 1993. Strict quality controls, the use of high quality materials, the steady further development of production and company processes and eventually an uncompromising service to our customers stand for the company history as well as philosophy.

Vorteile der Ni-Cd Batterie

- Gute Leistungsdaten im Hochstrombereich
- Hohe Zyklenfestigkeit
- Niedrige Betriebskosten – Life Cycle Costs
- Geringer Innenwiderstand
- Kein Risiko des plötzlichen Ausfalls oder thermischer Instabilität
- Keine Elektrolytschichtung
- Weder Korrosion noch Passivierung an den Elektroden
- Verringerter Kapazitätsverlust bei tiefen Temperaturen
- Kein Einfrieren des Elektrolyts bei Temperaturen unter 0 °C
- Extrem lange Lebensdauer bei hohen Temperaturen von über 20 Jahren im stationären Zyklusbetrieb
- Unempfindlich gegenüber Tiefentladung
- Großer Temperatureinsatzbereich von – 40 °C bis zu + 50 °C
- Sehr lange Lagerfähigkeit von mehreren Jahren im entladenen Zustand unter korrekten Bedingungen
- Robuste Konstruktion – unempfindlich gegenüber Wartungsfehlern
- Großzügige Elektrolytreserve – reduzierte Wartungskosten

GAZ® Ni-Cd Batterien

GAZ® Nickel-Cadmium Zellen mit Taschenplattenelektroden sowie die aus diesen Zellen bestehenden Batterien haben sich seit Jahrzehnten bei allen gestellten Anforderungen, vor allem aber unter extremsten Einsatzbedingungen, im höchsten Maße bewährt. Unsere Nickel-Cadmium Batterien mit Taschenplattenelektroden verkörpern eine stetig verbesserte und weiterentwickelte Technik basierend auf einer mehr als 100jährigen Erfahrung in Herstellung und Entwicklung. Ihre außergewöhnlichen Eigenschaften machen die GAZ® Nickel-Cadmium Batterie zu einer der zuverlässigsten Systeme, wenn eine kostengünstige, langlebige und sichere Lösung gewünscht wird.

GAZ® Ni-Cd Batteriezellen erfüllen alle Anforderungen gemäß IEC 60623 und EN 60623.

Konfigurationsformen

GAZ® Ni-Cd Zellen können in den verschiedensten Konstruktionsformen zu Batterien zusammengestellt werden, z. B.

- Aufstellung auf Batteriegestellen oder im Schrank
- Vormontage als Kompaktblock
- Montage im Kunststoffzellenträger, Edelstahlträger oder Batterietrog

Anwendungsgebiete

USV-Anlagen, Bahnbetrieb, Kraftwerke und Schaltstationen, regenerative Energieanlagen, Schiffsausrüstungen, Telekommunikation

Qualitätsmanagementsystem

Das Qualitätsmanagementsystem unseres Hauses ist bereits seit 1993 zertifiziert. Strenge Qualitätskontrollen, die Verwendung hochwertiger Materialien, die stetige Weiterentwicklung der Produktions- und Betriebsprozesse und schließlich der exzellente Service für unsere Kunden stehen für unsere Firmengeschichte und Philosophie.

KL ... P Battery Range

Batteriebaureihe KL ... P

KL ... P Battery Range

This GAZ® cell type has been especially designed for low rates of discharge over long periods, viz the current is relatively low in comparison with the total stored energy. The discharges can generally be infrequent and the recommended discharge time for the KL ... P range is 1 hour to 100 hours.

Important Notice

The nominal capacity C_5 is not the basis for the performance of the batteries. Performance depends on the battery construction, i.e. on the different battery ranges. Therefore, our discharge tables should be used to find out the appropriated cell type for a specific application. The nominal capacity C_5 of KL ... P range batteries is based on the available ampere hours (Ah) at a discharge rate of 5 hours to a final discharge voltage of 1.00 V per cell at $20\text{ °C} \pm 5\text{ °C}$.

Nominal voltage per cell is 1.2 V.

Discharging conditions

The discharge performances as well as the nominal capacities C_5 given in this brochure are only valid for fully charged cells in accordance with IEC 60623 und EN 60623, point 4.1.

Charging conditions KL ... P Battery Range

1. Constant voltage

Stand by
 Float: 1.40 – 1.42 V/cell
 Boost charge: 1.55 – 1.70 V/cell
 Buffer operation
 Average value: 1.55 – 1.70 V/cell
 Current limitation: $0.3 I_t$ A

2. Constant current at 25 °C [A]

Standard charge: $0.2 I_t$ A for 7 – 8 h
 Boost recharge: $0.3 I_t$ A for 2.5 h
 followed by $0.2 I_t$ A for 2.5 h
 Trickle charge: 0.001 – 0.002 A/Ah

Baureihe KL ... P

Ni-Cd Zellen dieser Baureihe sind speziell für niedrige Entladeströme während relativ langer Entladezeiten entwickelt worden. Die empfohlene Entladezeit für die KL ... P Baureihe beträgt 1 Stunde bis zu 100 Stunden.

Wichtig

Die Nennkapazität C_5 ist keine Bemessungsgrundlage für die Leistung. Die Leistung hängt von der Batteriekonstruktion, bzw. von der Typenbaureihe ab. Deshalb sollten unsere Entladetabellen genutzt werden, um den entsprechenden Zellentyp für eine bestimmte Anwendung zu bestimmen.

Die Nennkapazität C_5 der KL ... P Baureihe basiert auf den entnehmbaren Amperestunden (Ah) bei fünfständiger Entladung und auf einer Entladeschlussspannung von 1,00 V pro Zelle bei $20\text{ °C} \pm 5\text{ °C}$.

Die Nennspannung pro Zelle beträgt 1,2 V.

Entladeverhalten

Die in unseren Tabellen angegebenen Entladewerte sowie die Nennkapazitäten beruhen auf ordnungsgemäß geladenen Zellen laut IEC 60623 und EN 60623, Abs. 4.1.

Ladebedingungen Baureihe KL ... P

1. Konstanzspannung

Bereitschaftsbetrieb
 Erhaltungsladen: 1,40 – 1,42 V/Zelle
 Starkladen: 1,55 – 1,70 V/Zelle
 Pufferbetrieb
 Mittelwert: 1,55 – 1,70 V/Zelle
 Strombegrenzung: $0,3 I_t$ A

2. Konstantstrom bei 25 °C [A]

Standardladung: $0,2 I_t$ A während 7 – 8 h
 Starkladung: $0,3 I_t$ A während 2,5 h
 dann $0,2 I_t$ A während 2,5 h
 Erhaltungsladung: 0,001 – 0,002 A/Ah

Battery Layout

KL 11 P – KL 30 P

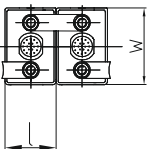

KL 40 P – KL 65 P

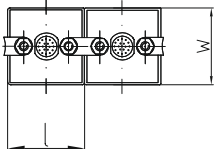

KL 80 P – KL 300 P

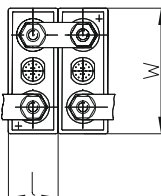

KL 340 P – KL 470 P (M 10)

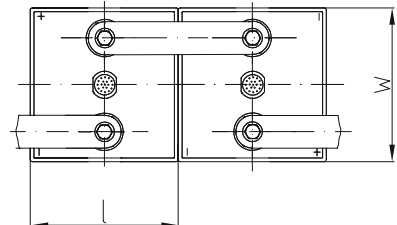

KL 520 P – KL 625 P (M 10)

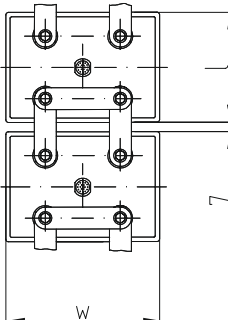

KL 650 P – KL 910 P (M 10)

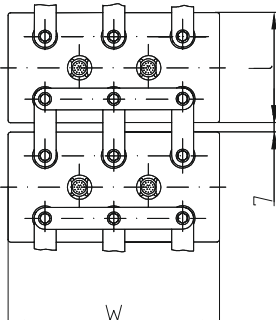

KL 1000 P – KL 1700 P (M 10)

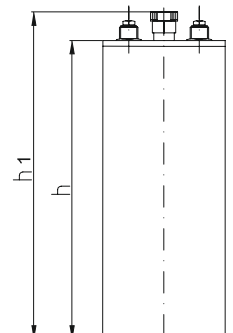
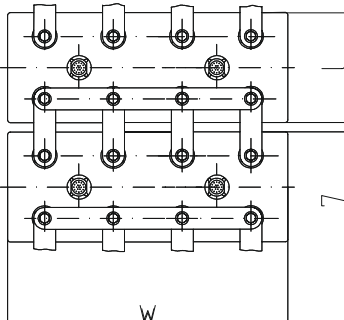

Technical Specifications / Technische Kenndaten

Cell type Zelltyp	Nominal Capacity C ₅ [Ah] at 1.00 V Nennkapazität C ₅ [Ah] bei 1,00 V	Dimensions / Abmessungen [mm]				Terminals / Pole		Weight / Gewicht [kg]	
		l	w	h	h ₁	Type / Art M = Nut / Mutter S = Screw / Schraube	Size / Größe	without Electrolyte / ohne Elektrolyt	Total Weight / Gesamtgewicht
KL 11 P	11	46	85	237	261	M	2 x M 10	0,8	1.2
KL 18 P	18	46	85	237	261	M	2 x M 10	0,9	1.3
KL 24 P	24	46	85	237	261	M	2 x M 10	1,1	1.4
KL 30 P	30	46	85	237	261	M	2 x M 10	1,3	1.5
KL 40 P	40	85	85	237	261	M	2 x M 10	1,8	2.5
KL 45 P	45	85	85	237	261	M	2 x M 10	1,9	2.6
KL 55 P	55	85	85	237	261	M	2 x M 10	2,1	2.7
KL 65 P	65	85	85	237	261	M	2 x M 10	2,3	2.8
KL 80 P	80	69	134	364	394	M	2 x M 16	3,4	5.1
KL 100 P	100	69	134	364	394	M	2 x M 16	3,8	5.3
KL 120 P	120	69	134	364	394	M	2 x M 16	4,0	5.6
KL 140 P	140	69	134	364	394	M	2 x M 16	4,5	5.8
KL 150 P	150	70	164	364	394	M	2 x M 16	4,9	6.7
KL 160 P	160	108	164	364	394	M	2 x M 16	5,7	9.3
KL 185 P	185	108	164	364	394	M	2 x M 16	6,3	9.7
KL 200 P	200	108	164	364	394	M	2 x M 16	6,7	10.1
KL 230 P	230	108	164	364	394	M	2 x M 16	7,5	10.5
KL 270 P	270	108	164	364	394	M	2 x M 16	8,3	10.9
KL 300 P	300	108	164	364	394	M	2 x M 16	9,1	11.3
KL 340 P	340	158	164	364	392	S	2 x M 10	11,4	16.4
KL 370 P	370	158	164	364	392	S	2 x M 10	12,2	16.8
KL 400 P	400	158	164	364	392	S	2 x M 10	13,0	17.2
KL 435 P	435	158	164	364	392	S	2 x M 10	13,8	17.6
KL 470 P	470	158	164	364	392	S	2 x M 10	14,6	18.0
KL 520 P	520	176	246	382	408	S	4 x M 10	18,3	26.0
KL 560 P	560	176	246	382	408	S	4 x M 10	18,8	27.0
KL 625 P	625	176	246	382	408	S	4 x M 10	20,4	28.0
KL 650 P	650	176	368	382	421	S	6 x M 10	23,7	37.3
KL 740 P	740	176	368	382	421	S	6 x M 10	25,9	38.9
KL 800 P	800	176	368	382	421	S	6 x M 10	26,5	40.4
KL 840 P	840	176	368	382	421	S	6 x M 10	28,1	40.5
KL 910 P	910	176	368	382	421	S	6 x M 10	30,5	42.0
KL 1000 P	1000	176	448	382	421	S	8 x M 10	39,3	50.0
KL 1040 P	1040	176	448	382	421	S	8 x M 10	40,5	51.0
KL 1120 P	1120	176	448	382	421	S	8 x M 10	41,5	52.5
KL 1250 P	1250	176	558	382	421	S	8 x M 10	42,5	61.5
KL 1350 P	1350	176	558	382	421	S	8 x M 10	44,9	63.0
KL 1400 P	1400	176	558	382	421	S	8 x M 10	46,5	64.5
KL 1500 P	1500	176	558	382	421	S	8 x M 10	48,9	65.5
KL 1620 P	1620	176	558	382	421	S	8 x M 10	52,2	67.0
KL 1700 P	1700	176	558	382	421	S	8 x M 10	55,5	68.0

Final discharge voltage per cell / Entladeschlussspannung pro Zelle

1.15 V

Cell type / Zelltyp											
	30 min	1 h	2 h	3 h	4 h	5 h	6 h	7 h	8 h	9 h	10 h
KL 11 P	5.95	4.93	3.45	2.66	2.29	2.05	1.78	1.54	1.36	1.22	1.10
KL 18 P	9.78	8.07	5.64	4.35	3.75	3.36	2.91	2.57	2.25	2.00	1.80
KL 24 P	13.04	10.76	7.52	5.80	5.00	4.48	3.88	3.42	3.00	2.66	2.40
KL 30 P	16.30	13.45	9.40	7.25	6.25	5.60	4.85	4.28	3.75	3.33	3.00
KL 40 P	20.00	17.20	12.90	9.80	8.40	7.40	6.30	5.50	4.80	4.30	3.90
KL 45 P	22.50	19.40	14.60	11.00	9.40	8.30	7.10	6.10	5.40	4.80	4.40
KL 55 P	27.50	23.70	17.80	13.50	11.50	10.20	8.70	7.50	6.60	5.90	5.30
KL 65 P	32.50	28.00	21.00	16.00	13.60	12.00	10.30	8.90	7.80	7.00	6.30
KL 80 P	38.40	33.60	25.80	20.30	16.80	14.20	12.00	10.40	9.40	8.40	7.50
KL 100 P	48.00	42.00	32.30	25.40	21.00	17.70	15.00	13.00	11.70	10.50	9.40
KL 120 P	57.60	50.40	38.80	30.50	25.20	21.20	18.00	15.60	14.00	12.60	11.30
KL 140 P	67.20	58.80	45.20	35.60	29.40	24.80	21.00	18.20	16.40	14.70	13.20
KL 150 P	69.95	61.10	47.50	37.70	31.35	26.60	22.65	19.60	17.45	15.60	14.05
KL 160 P	72.70	63.40	49.80	39.80	33.30	28.40	24.30	21.00	18.50	16.50	14.90
KL 185 P	73.70	64.30	52.60	43.60	37.30	32.60	28.50	25.00	21.70	18.80	16.70
KL 200 P	79.70	69.50	56.80	47.20	40.30	35.20	30.80	26.70	23.30	20.80	18.70
KL 230 P	91.60	80.00	65.30	54.30	46.40	40.50	35.40	30.70	26.80	23.90	21.50
KL 270 P	107.60	93.90	76.70	63.70	54.40	47.60	41.60	36.00	31.50	28.00	25.20
KL 300 P	119.50	104.30	85.20	70.80	60.50	52.90	46.20	40.00	34.90	31.10	28.00
KL 340 P	141.00	118.00	94.00	80.00	69.00	60.00	50.30	43.50	38.30	34.30	31.10
KL 370 P	154.00	128.00	102.00	87.00	75.00	65.00	54.80	47.30	41.70	37.30	33.90
KL 400 P	166.00	139.00	111.00	94.00	81.00	71.00	59.20	51.10	45.10	40.30	36.30
KL 435 P	180.00	151.00	120.00	103.00	88.00	77.00	64.40	55.60	49.10	43.90	39.80
KL 470 P	195.00	163.00	130.00	111.00	95.00	83.00	69.60	60.10	53.00	47.40	43.00
KL 520 P	215.00	180.00	143.00	122.00	105.00	91.00	76.00	66.00	58.00	52.00	47.00
KL 560 P	232.00	194.00	154.00	131.00	113.00	98.00	82.00	71.00	62.00	56.00	51.00
KL 625 P	258.00	216.00	172.00	147.00	126.00	109.00	91.00	79.00	70.00	63.00	56.00
KL 650 P	269.00	225.00	179.00	153.00	131.00	114.00	95.00	83.00	73.00	65.00	59.00
KL 740 P	306.00	256.00	204.00	174.00	149.00	130.00	108.00	94.00	83.00	74.00	67.00
KL 800 P	331.00	277.00	221.00	188.00	161.00	141.00	117.00	102.00	90.00	80.00	72.00
KL 840 P	347.00	291.00	231.00	197.00	170.00	147.00	123.00	107.00	94.00	84.00	76.00
KL 910 P	376.00	315.00	250.00	213.00	184.00	159.00	133.00	116.00	102.00	91.00	82.00
KL 1000 P	415.00	347.00	277.00	235.00	202.00	177.00	147.00	127.00	112.00	100.00	90.00
KL 1040 P	432.00	361.00	288.00	244.00	210.00	184.00	153.00	132.00	116.00	104.00	94.00
KL 1120 P	465.00	389.00	310.00	263.00	226.00	198.00	165.00	142.00	125.00	112.00	101.00
KL 1250 P	519.00	434.00	346.00	294.00	253.00	221.00	184.00	159.00	140.00	125.00	113.00
KL 1350 P	561.00	469.00	374.00	318.00	273.00	239.00	199.00	172.00	151.00	135.00	122.00
KL 1400 P	581.00	486.00	388.00	329.00	283.00	248.00	206.00	178.00	157.00	140.00	127.00
KL 1500 P	623.00	521.00	416.00	353.00	303.00	266.00	221.00	191.00	168.00	150.00	135.00
KL 1620 P	673.00	563.00	449.00	381.00	327.00	287.00	239.00	206.00	181.00	162.00	146.00
KL 1700 P	706.00	590.00	471.00	400.00	343.00	301.00	250.00	216.00	190.00	170.00	153.00

Final discharge voltage per cell / Entladeschlussspannung pro Zelle

1.10 V

Cell type / Zelltyp											
	30 min	1 h	2 h	3 h	4 h	5 h	6 h	7 h	8 h	9 h	10 h
KL 11 P	7.46	6.22	4.25	3.10	2.42	2.15	1.82	1.60	1.41	1.25	1.13
KL 18 P	12.21	10.17	6.96	5.07	3.96	3.51	2.97	2.63	2.30	2.05	1.84
KL 24 P	16.28	13.56	9.28	6.76	5.28	4.68	3.96	3.51	3.07	2.73	2.46
KL 30 P	20.35	16.95	11.60	8.45	6.60	5.85	4.95	4.39	3.84	3.41	3.07
KL 40 P	26.10	21.50	15.70	11.70	9.20	7.70	6.50	5.60	4.90	4.40	3.90
KL 45 P	29.50	24.20	17.70	13.20	10.30	8.60	7.30	6.40	5.60	4.90	4.40
KL 55 P	36.00	29.60	21.60	16.10	12.60	10.60	8.90	7.80	6.80	6.00	5.40
KL 65 P	42.50	35.00	25.50	19.00	14.90	12.50	10.50	9.10	8.00	7.10	6.40
KL 80 P	49.20	41.60	31.40	24.40	19.20	15.60	13.20	11.30	9.90	8.80	8.00
KL 100 P	61.50	52.00	39.20	30.50	24.00	19.50	16.50	14.10	12.30	11.00	10.00
KL 120 P	73.80	62.40	47.00	36.60	28.80	23.40	19.40	17.00	14.80	13.20	12.00
KL 140 P	86.10	72.80	54.90	42.70	33.60	27.30	23.10	19.80	17.30	15.40	14.00
KL 150 P	89.50	75.65	57.65	45.35	35.85	29.10	24.70	21.25	18.60	16.55	15.00
KL 160 P	92.90	78.50	60.40	48.00	38.10	30.90	26.30	22.70	19.90	17.70	16.00
KL 185 P	94.30	79.60	64.20	53.00	42.90	34.70	30.10	26.40	23.10	20.60	18.50
KL 200 P	101.90	86.00	69.40	57.30	46.30	37.50	32.60	28.60	25.00	22.20	20.00
KL 230 P	117.20	98.90	79.80	65.90	53.30	43.10	37.50	32.90	28.80	25.60	23.00
KL 270 P	137.60	116.10	93.70	77.40	62.60	50.60	44.00	38.60	33.80	30.00	27.00
KL 300 P	152.80	129.00	104.10	86.00	69.50	56.20	48.80	42.80	37.50	33.30	30.00
KL 340 P	188.00	163.00	120.00	95.00	80.00	67.00	55.80	48.10	42.40	37.90	34.30
KL 370 P	204.00	177.00	131.00	103.00	87.00	72.00	60.70	52.40	46.10	41.30	37.30
KL 400 P	221.00	191.00	141.00	111.00	94.00	78.00	65.60	56.60	49.90	44.60	40.30
KL 435 P	240.00	208.00	154.00	121.00	102.00	85.00	71.40	61.50	54.20	48.50	43.90
KL 470 P	260.00	225.00	166.00	131.00	110.00	92.00	77.10	66.50	58.60	52.40	47.40
KL 520 P	287.00	248.00	183.00	144.00	121.00	101.00	85.00	73.00	64.00	57.00	52.00
KL 560 P	309.00	267.00	197.00	155.00	130.00	109.00	92.00	79.00	69.00	61.00	56.00
KL 625 P	345.00	298.00	220.00	173.00	145.00	121.00	102.00	88.00	77.00	69.00	63.00
KL 650 P	359.00	310.00	229.00	180.00	151.00	126.00	106.00	91.00	80.00	71.00	65.00
KL 740 P	408.00	353.00	260.00	205.00	172.00	144.00	121.00	104.00	91.00	81.00	74.00
KL 800 P	441.00	382.00	281.00	222.00	186.00	156.00	131.00	112.00	98.00	88.00	80.00
KL 840 P	464.00	401.00	296.00	233.00	195.00	163.00	137.00	118.00	103.00	92.00	84.00
KL 910 P	503.00	434.00	321.00	252.00	211.00	177.00	148.00	128.00	112.00	100.00	91.00
KL 1000 P	552.00	477.00	352.00	277.00	235.00	195.00	162.00	140.00	122.00	110.00	100.00
KL 1040 P	574.00	496.00	366.00	288.00	244.00	203.00	168.00	146.00	127.00	114.00	104.00
KL 1120 P	618.00	534.00	394.00	310.00	263.00	218.00	181.00	157.00	137.00	123.00	112.00
KL 1250 P	690.00	596.00	440.00	346.00	294.00	244.00	203.00	175.00	153.00	138.00	125.00
KL 1350 P	745.00	644.00	475.00	374.00	318.00	264.00	219.00	189.00	165.00	149.00	135.00
KL 1400 P	773.00	668.00	493.00	388.00	329.00	273.00	227.00	196.00	171.00	155.00	140.00
KL 1500 P	828.00	716.00	528.00	416.00	353.00	293.00	243.00	210.00	183.00	165.00	150.00
KL 1620 P	894.00	773.00	570.00	449.00	381.00	316.00	262.00	227.00	198.00	178.00	162.00
KL 1700 P	938.00	811.00	598.00	471.00	400.00	332.00	275.00	238.00	207.00	187.00	170.00

Final discharge voltage per cell / Entladeschlussspannung pro Zelle

1.05 V

Cell type/Zelltyp											
	30 min	1 h	2 h	3 h	4 h	5 h	6 h	7 h	8 h	9 h	10 h
KL 11 P	9.53	7.37	4.84	3.34	2.62	2.18	1.84	1.61	1.42	1.26	1.14
KL 18 P	15.60	12.06	7.92	5.46	4.29	3.57	3.02	2.66	2.33	2.06	1.86
KL 24 P	20.80	16.08	10.96	7.28	5.72	4.76	4.02	3.54	3.11	2.75	2.48
KL 30 P	26.00	20.10	13.20	9.10	7.15	5.95	5.03	4.43	3.89	3.44	3.10
KL 40 P	32.00	25.20	16.90	12.30	9.50	7.90	6.60	5.70	5.00	4.50	4.10
KL 45 P	36.00	28.40	19.10	13.80	10.60	8.80	7.40	6.50	5.60	5.10	4.60
KL 55 P	44.00	34.70	23.30	16.90	13.00	10.80	9.10	7.90	6.90	6.20	5.60
KL 65 P	52.00	41.00	27.50	20.00	15.40	12.80	10.70	9.30	8.20	7.30	6.60
KL 80 P	62.00	50.80	35.60	25.70	19.50	15.80	13.30	11.40	9.90	9.00	8.10
KL 100 P	77.50	63.50	44.50	32.10	24.40	19.80	16.60	14.30	12.40	11.20	10.10
KL 120 P	93.00	76.20	53.40	38.50	29.20	23.80	19.90	17.10	14.90	13.40	12.10
KL 140 P	108.50	88.90	62.30	44.90	34.10	27.70	23.20	20.00	17.40	15.70	14.10
KL 150 P	112.75	92.30	65.40	47.95	37.00	29.70	24.90	21.50	18.80	16.85	15.15
KL 160 P	117.00	95.70	68.50	51.00	39.30	31.70	26.60	23.00	20.20	18.00	16.20
KL 185 P	118.80	96.60	72.50	57.70	45.20	36.40	30.50	26.70	23.40	20.70	18.70
KL 200 P	124.40	102.20	78.40	62.40	48.90	39.40	33.00	28.90	25.30	22.40	20.20
KL 230 P	143.10	117.60	90.20	71.80	56.20	45.30	38.00	33.20	29.10	25.80	23.20
KL 270 P	168.00	138.00	105.90	84.30	66.00	53.10	44.60	39.00	34.10	30.30	27.30
KL 300 P	186.00	153.30	117.60	93.60	73.30	59.00	49.50	42.90	37.70	33.60	30.30
KL 340 P	224.00	188.00	140.00	104.00	82.00	67.30	56.40	48.60	42.80	38.30	34.70
KL 370 P	244.00	205.00	153.00	113.00	90.00	73.00	61.40	52.90	46.60	41.70	37.70
KL 400 P	264.00	221.00	165.00	123.00	97.00	79.00	66.40	57.20	50.40	45.10	40.80
KL 435 P	287.00	241.00	180.00	133.00	105.50	86.00	72.20	62.20	54.80	49.10	44.30
KL 470 P	310.00	260.00	194.00	144.00	114.00	93.00	78.00	67.20	59.20	53.00	47.90
KL 520 P	342.00	287.00	214.00	159.00	126.00	102.00	86.00	74.00	65.00	58.00	53.00
KL 560 P	368.00	309.00	230.00	171.00	136.00	110.00	93.00	80.00	70.00	62.00	57.00
KL 625 P	411.00	345.00	257.00	191.00	151.00	123.00	103.00	89.00	78.00	70.00	64.00
KL 650 P	428.00	359.00	268.00	199.00	158.00	128.00	108.00	93.00	81.00	73.00	66.00
KL 740 P	487.00	408.00	305.00	226.00	179.00	145.00	122.00	105.00	93.00	83.00	75.00
KL 800 P	526.00	441.00	330.00	244.00	194.00	157.00	132.00	114.00	101.00	90.00	81.00
KL 840 P	552.00	464.00	346.00	257.00	204.00	165.00	139.00	120.00	105.00	94.00	86.00
KL 910 P	598.00	503.00	375.00	278.00	221.00	179.00	151.00	130.00	114.00	102.00	93.00
KL 1000 P	660.00	552.00	412.00	307.00	242.00	197.00	165.00	142.00	125.00	112.00	102.00
KL 1040 P	686.00	574.00	428.00	319.00	252.00	205.00	172.00	148.00	130.00	116.00	106.00
KL 1120 P	739.00	618.00	461.00	344.00	271.00	221.00	185.00	159.00	140.00	125.00	114.00
KL 1250 P	825.00	690.00	515.00	384.00	303.00	246.00	206.00	178.00	156.00	140.00	128.00
KL 1350 P	891.00	745.00	556.00	415.00	327.00	266.00	222.00	192.00	168.00	151.00	138.00
KL 1400 P	924.00	773.00	577.00	430.00	339.00	276.00	231.00	199.00	175.00	157.00	143.00
KL 1500 P	990.00	828.00	618.00	461.00	363.00	296.00	248.00	213.00	188.00	168.00	153.00
KL 1620 P	1069.00	894.00	667.00	498.00	392.00	320.00	268.00	230.00	203.00	181.00	165.00
KL 1700 P	1122.00	938.00	700.00	522.00	411.00	335.00	281.00	241.00	213.00	190.00	173.00

Final discharge voltage per cell / Entladeschlussspannung pro Zelle

1.00 V

Cell type/Zelltyp											
	30 min	1 h	2 h	3 h	4 h	5 h	6 h	7 h	8 h	9 h	10 h
KL 11 P	11.33	8.58	5.21	3.65	2.74	2.20	1.86	1.64	1.44	1.28	1.15
KL 18 P	18.54	14.04	8.52	5.97	4.48	3.60	3.04	2.69	2.35	2.09	1.88
KL 24 P	24.72	18.72	11.36	7.96	5.98	4.80	4.06	3.58	3.14	2.79	2.51
KL 30 P	30.90	23.40	14.20	9.95	7.47	6.00	5.07	4.48	3.92	3.49	3.14
KL 40 P	37.20	28.30	17.50	12.60	9.70	8.00	6.70	5.80	5.20	4.60	4.20
KL 45 P	41.90	31.80	19.70	14.10	10.90	9.00	7.50	6.50	5.80	5.20	4.70
KL 55 P	51.20	38.90	24.10	17.30	13.30	11.00	9.20	8.00	7.10	6.30	5.80
KL 65 P	60.50	46.00	28.50	20.50	15.70	13.00	10.90	9.50	8.40	7.50	6.80
KL 80 P	74.80	59.20	37.60	26.00	19.70	16.00	13.40	11.60	10.10	9.10	8.20
KL 100 P	93.50	74.00	47.00	32.50	24.60	20.00	16.80	14.50	12.70	11.30	10.20
KL 120 P	112.20	88.80	56.40	39.00	29.60	24.00	20.20	17.40	15.20	13.60	12.20
KL 140 P	130.90	103.60	65.80	45.50	34.60	28.00	23.50	20.30	17.70	15.90	14.30
KL 150 P	132.45	105.30	69.25	48.90	37.10	30.00	25.25	21.80	19.05	17.05	15.35
KL 160 P	134.00	107.00	72.70	52.30	39.60	32.00	27.00	23.30	20.40	18.20	16.40
KL 185 P	135.40	108.70	77.70	60.30	46.00	37.00	30.80	26.80	23.50	20.80	18.80
KL 200 P	146.30	117.50	84.00	65.10	49.70	40.00	33.30	29.00	25.40	22.50	20.30
KL 230 P	168.30	135.10	96.60	74.90	57.20	46.00	38.30	33.40	29.20	25.90	23.40
KL 270 P	197.60	158.60	113.40	87.90	67.10	54.00	45.00	39.20	34.30	30.40	27.40
KL 300 P	219.50	176.10	126.00	97.70	74.50	60.00	50.20	43.20	38.00	33.80	30.50
KL 340 P	260.00	217.00	152.00	106.00	83.00	68.00	57.00	49.20	43.30	38.70	35.10
KL 370 P	283.00	236.00	165.00	115.00	90.50	74.00	62.00	53.50	47.10	42.10	38.20
KL 400 P	306.00	255.00	179.00	124.00	98.00	80.00	67.10	57.90	50.90	45.50	41.30
KL 435 P	333.00	278.00	194.00	135.00	106.00	87.00	72.90	62.90	55.30	49.50	44.90
KL 470 P	360.00	300.00	210.00	146.00	115.00	94.00	78.80	68.00	59.80	53.50	48.50
KL 520 P	398.00	331.00	232.00	161.00	127.00	104.00	87.00	75.00	66.00	59.00	54.00
KL 560 P	429.00	356.00	250.00	173.00	137.00	112.00	94.00	81.00	71.00	64.00	58.00
KL 625 P	478.00	398.00	279.00	194.00	153.00	125.00	105.00	90.00	79.00	71.00	65.00
KL 650 P	498.00	414.00	290.00	201.00	159.00	130.00	109.00	94.00	83.00	74.00	68.00
KL 740 P	566.00	471.00	330.00	229.00	181.00	148.00	124.00	107.00	94.00	84.00	77.00
KL 800 P	612.00	509.00	357.00	248.00	196.00	160.00	134.00	116.00	102.00	91.00	83.00
KL 840 P	643.00	535.00	375.00	260.00	205.00	168.00	141.00	121.00	107.00	95.00	87.00
KL 910 P	697.00	580.00	406.00	282.00	222.00	182.00	153.00	131.00	116.00	103.00	94.00
KL 1000 P	765.00	637.00	447.00	310.00	245.00	200.00	167.00	144.00	127.00	114.00	103.00
KL 1040 P	796.00	662.00	465.00	322.00	255.00	208.00	174.00	150.00	132.00	119.00	107.00
KL 1120 P	857.00	713.00	501.00	347.00	274.00	224.00	187.00	161.00	142.00	128.00	115.00
KL 1250 P	956.00	796.00	559.00	388.00	306.00	250.00	209.00	180.00	159.00	143.00	129.00
KL 1350 P	1032.00	860.00	604.00	419.00	330.00	270.00	226.00	194.00	172.00	154.00	139.00
KL 1400 P	1071.00	892.00	626.00	435.00	343.00	280.00	234.00	202.00	178.00	160.00	144.00
KL 1500 P	1148.00	956.00	671.00	465.00	368.00	300.00	251.00	216.00	191.00	171.00	155.00
KL 1620 P	1240.00	1032.00	725.00	502.00	397.00	324.00	271.00	233.00	206.00	185.00	167.00
KL 1700 P	1301.00	1083.00	760.00	527.00	417.00	340.00	284.00	245.00	216.00	194.00	176.00

KM ... P Battery Range

Batteriebaureihe KM ... P

KM ... P Battery Range

This GAZ® M type has been especially designed for "mixed loads" that include a mixture of high and low rates of discharge. It is used for frequent and infrequent discharges and the recommended discharge time is 30 min to 120 min.

Important Notice

The rated capacity C_5 is not the basis for the performance of the batteries. Performance depends on the battery construction, i.e. on the different battery ranges. Therefore, our discharge tables should be used to find out the appropriated cell type for a specific application.

The rated capacity C_5 of KM ... P range batteries is based on the available ampere hours (Ah) at a discharge rate of 5 hours to a final discharge voltage of 1.15 V per cell at $20\text{ °C} \pm 5\text{ °C}$.

Nominal voltage per cell is 1.2 V.

Discharging conditions

The discharge performances as well as the nominal capacities C_5 given in this brochure are only valid for fully charged cells in accordance with IEC 60623 and EN 60623, point 4.1.

Charging conditions KM ... P Battery Range

1. Constant voltage

Stand by	
Float:	1.40 – 1.42 V/cell
Boost charge:	1.55 – 1.70 V/cell
Buffer operation	
Average value:	1.55 – 1.70 V/cell
Current limitation:	$0.4 I_t$ A

2. Constant current at 25 °C [A]

Standard charge:	$0.2 I_t$ A for 7 – 8 h
Boost recharge:	$0.4 I_t$ A for 2.5 h
	followed by $0.2 I_t$ A for 2.5 h
Trickle charge:	0.001 – 0.002 A/Ah

Baureihe KL ... P

Ni-Cd Zellen dieser Baureihe finden speziell bei "Mischlasten" mit hohen und niedrigen Entladeströmen Anwendung. Die empfohlene Entladezeit für die KM ... P oder TP Baureihe beträgt 30 min bis zu 120 min.

Wichtig

Die Bemessungskapazität C_5 ist keine Bemessungsgrundlage für die Leistung. Die Leistung hängt von der Batteriekonstruktion, bzw. von der Typenbaureihe ab. Deshalb sollten unsere Entladetabellen genutzt werden, um den entsprechenden Zellentyp für eine bestimmte Anwendung zu bestimmen.

Die Bemessungskapazität C_5 der KM ... P Baureihe basiert auf den entnehmbaren Amperestunden (Ah) bei fünfstündiger Entladung und auf einer Entladeschlussspannung von 1,15 V pro Zelle bei $20\text{ °C} \pm 5\text{ °C}$.

Die Nennspannung pro Zelle beträgt 1,2 V.

Entladeverhalten

Die in unseren Tabellen angegebenen Entladewerte sowie die Nennkapazitäten beruhen auf ordnungsgemäß geladenen Zellen laut IEC 60623 und EN 60623, Abs. 4.1.

Ladebedingungen Baureihe KM ... P

1. Konstanzspannung

Bereitschaftsbetrieb	
Erhaltungsladen:	1,40 – 1,42 V/Zelle
Starkladen:	1,55 – 1,70 V/Zelle
Pufferbetrieb	
Mittelwert:	1,55 – 1,70 V/Zelle
Strombegrenzung:	$0,4 I_t$ A

2. Konstantstrom bei 25 °C [A]

Standardladung:	$0,2 I_t$ A während 7 – 8 h
Starkladung:	$0,4 I_t$ A während 2,5 h
	dann $0,2 I_t$ A während 2,5 h
Erhaltungsladung:	0,001 – 0,002 A/Ah

Battery Layout

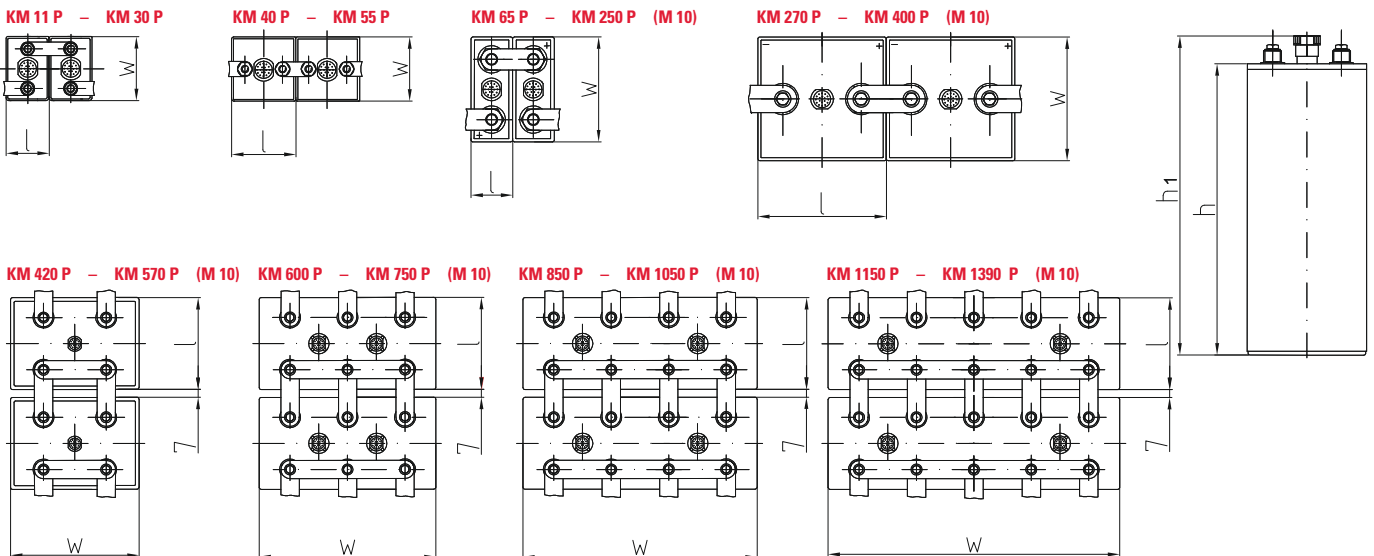

Technical Specifications / Technische Kenndaten

Cell type Zelltyp	Nominal Capacity C ₅ [Ah] at 1.15 V Nennkapazität C ₅ [Ah] bei 1,15 V	Dimensions / Abmessungen [mm]				Terminals / Pole		Weight / Gewicht [kg]	
		l	w	h	h ₁	Type / Art M = Nut / Mutter S = Screw / Schraube	Size / Größe	without Electrolyte / ohne Elektrolyt	Total Weight / Gesamtgewicht
KM 11 P	11	46	85	167	191	M	2 x M 10	0.7	1.0
KM 18 P	18	46	85	237	261	M	2 x M 10	1.0	1.5
KM 24 P	24	46	85	237	261	M	2 x M 10	1.2	1.6
KM 30 P	30	46	85	237	261	M	2 x M 10	1.4	1.7
KM 40 P	40	85	85	237	261	M	2 x M 10	1.9	2.8
KM 48 P	48	85	85	237	261	M	2 x M 10	2.1	2.8
KM 55 P	55	85	85	237	261	M	2 x M 10	2.3	3.0
KM 65 P	65	53	134	364	392	S	2 x M 8	3.6	4.9
KM 75 P	75	53	134	364	392	S	2 x M 8	3.8	5.0
KM 90 P	90	69	134	364	392	S	2 x M 8	4.4	6.2
KM 110 P	110	69	134	364	392	S	2 x M 8	4.9	6.5
KM 125 P	125	70	164	364	392	S	2 x M 8	5.6	7.7
KM 140 P	140	70	164	364	392	S	2 x M 8	6.0	7.8
KM 160 P	160	108	164	364	392	S	2 x M 8	6.9	10.6
KM 185 P	185	108	164	364	392	S	2 x M 8	7.5	10.9
KM 205 P	205	108	164	364	392	S	2 x M 8	8.3	11.2
KM 225 P	225	108	164	364	392	S	2 x M 8	8.8	11.6
KM 250 P	250	108	164	364	392	S	2 x M 8	9.6	12.2
KM 270 P	270	164	158	364	392	S	2 x M 10	11.2	16.3
KM 300 P	300	164	158	364	392	S	2 x M 10	11.5	16.5
KM 320 P	320	164	158	364	392	S	2 x M 10	12.2	17.0
KM 340 P	340	164	158	364	392	S	2 x M 10	13.0	17.5
KM 355 P	355	164	158	364	392	S	2 x M 10	13.7	18.0
KM 380 P	380	164	158	364	392	S	2 x M 10	14.3	18.6
KM 400 P	400	164	158	364	392	S	2 x M 10	15.1	18.9
KM 420 P	420	176	246	382	408	S	4 x M 10	18.7	25.4
KM 450 P	450	176	246	382	408	S	4 x M 10	20.0	27.3
KM 470 P	470	176	246	382	408	S	4 x M 10	20.9	28.5
KM 500 P	500	176	246	382	408	S	4 x M 10	21.2	28.3
KM 520 P	520	176	246	382	408	S	4 x M 10	22.2	29.1
KM 550 P	550	176	246	382	408	S	4 x M 10	22.4	29.3
KM 570 P	570	176	246	382	408	S	4 x M 10	23.2	30.4
KM 600 P	600	176	368	382	421	S	6 x M 10	27.0	40.7
KM 630 P	630	176	368	382	421	S	6 x M 10	28.4	42.7
KM 675 P	675	176	368	382	421	S	6 x M 10	30.8	43.7
KM 705 P	705	176	368	382	421	S	6 x M 10	29.5	41.9
KM 750 P	750	176	368	382	421	S	6 x M 10	32.0	43.1
KM 850 P	850	176	448	382	421	S	8 x M 10	36.2	48.8
KM 950 P	950	176	448	382	421	S	8 x M 10	40.7	53.2
KM 1000 P	1000	176	448	382	421	S	8 x M 10	42.8	56.0
KM 1050 P	1050	176	448	382	421	S	8 x M 10	44.9	58.8
KM 1150 P	1150	176	558	382	421	S	10 x M 10	48.2	63.4
KM 1250 P	1250	176	558	382	421	S	10 x M 10	52.4	68.9
KM 1390 P	1390	176	558	382	421	S	10 x M 10	56.2	77.0

Final discharge voltage per cell / Entladeschlussspannung pro Zelle

1.15 V

Cell type / Zelltyp										
	5 min	10 min	20 min	30 min	1 h	1.5 h	2 h	3 h	5 h	
KM 11 P	8.00	7.40	6.60	6.20	5.10	4.29	3.70	2.86	2.20	
KM 18 P	13.10	12.20	10.80	10.10	8.30	7.00	6.10	4.68	3.60	
KM 24 P	17.50	16.20	14.40	13.50	11.00	9.40	8.10	6.24	4.80	
KM 30 P	21.90	20.30	18.00	16.90	13.80	11.70	10.10	7.80	6.00	
KM 40 P	30.80	27.10	24.00	22.50	18.30	15.60	13.40	10.40	8.00	
KM 48 P	40.40	35.60	31.50	29.60	23.50	20.50	17.70	13.50	9.60	
KM 55 P	50.00	44.00	39.00	36.60	28.60	25.30	22.00	16.50	11.00	
KM 65 P	51.00	48.00	44.00	41.00	32.00	27.10	23.90	17.80	13.00	
KM 75 P	59.00	56.00	50.00	47.00	37.00	31.30	27.50	20.50	15.00	
KM 90 P	71.00	67.00	61.00	56.00	44.00	37.60	33.10	24.60	18.00	
KM 110 P	87.00	82.00	74.00	69.00	54.00	45.90	40.40	30.10	22.00	
KM 125 P	98.00	88.00	81.00	78.00	59.00	51.00	44.50	35.40	25.00	
KM 140 P	109.00	99.00	89.00	81.00	66.00	57.00	49.90	39.60	28.00	
KM 160 P	125.00	113.00	101.00	92.00	76.00	65.00	57.00	45.30	32.00	
KM 185 P	144.00	131.00	117.00	106.00	88.00	75.00	66.00	52.30	37.00	
KM 205 P	160.00	145.00	130.00	118.00	97.00	83.00	73.00	58.00	41.00	
KM 225 P	169.00	153.00	137.00	124.00	102.00	91.00	80.00	60.00	45.00	
KM 250 P	187.00	170.00	152.00	138.00	114.00	101.00	89.00	66.70	50.00	
KM 270 P	202.00	183.00	164.00	149.00	123.00	109.00	96.00	72.00	54.00	
KM 300 P	232.00	215.00	191.00	177.00	146.00	132.00	112.00	84.00	60.00	
KM 320 P	248.00	229.00	203.00	189.00	156.00	141.00	120.00	89.60	64.00	
KM 340 P	263.00	243.00	216.00	201.00	166.00	150.00	127.00	95.20	68.00	
KM 355 P	275.00	254.00	226.00	209.00	173.00	157.00	133.00	99.00	71.00	
KM 380 P	294.00	272.00	242.00	224.00	185.00	168.00	142.00	106.00	76.00	
KM 400 P	302.00	279.00	248.00	230.00	190.00	172.00	146.00	112.00	80.00	
KM 420 P	317.00	293.00	260.00	242.00	200.00	181.00	153.00	118.00	84.00	
KM 450 P	337.00	306.00	277.00	248.00	205.00	192.00	180.00	135.00	90.00	
KM 470 P	352.00	320.00	289.00	259.00	214.00	201.00	188.00	141.00	94.00	
KM 500 P	374.00	340.00	308.00	276.00	228.00	213.00	200.00	150.00	100.00	
KM 520 P	389.00	354.00	320.00	287.00	237.00	222.00	208.00	156.00	104.00	
KM 550 P	412.00	374.00	339.00	303.00	251.00	235.00	220.00	165.00	110.00	
KM 570 P	427.00	388.00	351.00	314.00	260.00	244.00	228.00	171.00	114.00	
KM 600 P	449.00	408.00	369.00	331.00	273.00	256.00	240.00	180.00	120.00	
KM 630 P	471.00	428.00	387.00	348.00	287.00	269.00	252.00	189.00	126.00	
KM 675 P	506.00	459.00	416.00	372.00	308.00	288.00	270.00	203.00	135.00	
KM 705 P	528.00	479.00	434.00	389.00	322.00	301.00	282.00	212.00	141.00	
KM 750 P	562.00	510.00	462.00	413.00	342.00	320.00	300.00	225.00	150.00	
KM 850 P	637.00	578.00	524.00	468.00	388.00	363.00	340.00	255.00	170.00	
KM 950 P	712.00	646.00	585.00	523.00	433.00	405.00	380.00	285.00	190.00	
KM 1000 P	749.00	680.00	616.00	551.00	456.00	427.00	400.00	300.00	200.00	
KM 1050 P	786.00	714.00	647.00	579.00	479.00	448.00	420.00	315.00	210.00	
KM 1150 P	861.00	782.00	708.00	634.00	524.00	491.00	460.00	345.00	230.00	
KM 1250 P	936.00	850.00	769.00	689.00	569.00	533.00	500.00	375.00	250.00	
KM 1390 P	1041.00	945.00	855.00	766.00	633.00	593.00	556.00	417.00	278.00	

Final discharge voltage per cell / Entladeschlussspannung pro Zelle

1.10 V

Cell type / Zelltyp										
	5 min	10 min	20 min	30 min	1 h	1.5 h	2 h	3 h	5 h	
KM 11 P	11.70	10.20	8.60	8.00	6.50	5.24	4.47	3.30	2.33	
KM 18 P	19.10	16.60	14.10	13.10	10.60	8.60	7.30	5.40	3.82	
KM 24 P	25.40	22.20	18.80	17.40	14.10	11.40	9.80	7.20	5.09	
KM 30 P	31.80	27.70	23.50	21.80	17.60	14.30	12.20	9.00	6.36	
KM 40 P	38.80	34.50	30.80	28.30	23.40	19.00	16.40	12.00	8.48	
KM 48 P	50.90	45.30	40.40	37.20	28.80	24.20	20.60	15.10	10.00	
KM 55 P	63.00	56.00	50.00	46.00	34.10	29.40	24.80	18.10	11.50	
KM 65 P	71.00	66.00	59.00	54.00	41.00	33.40	28.80	20.40	13.80	
KM 75 P	82.00	76.00	68.00	62.00	48.00	38.60	33.20	23.50	15.90	
KM 90 P	98.00	92.00	82.00	74.00	57.00	46.30	39.80	28.20	19.10	
KM 110 P	120.00	112.00	100.00	91.00	70.00	56.60	48.70	34.50	23.30	
KM 125 P	128.00	116.00	107.00	98.00	75.00	64.00	54.30	39.60	26.30	
KM 140 P	143.00	130.00	120.00	109.00	88.00	72.00	60.80	44.40	29.40	
KM 160 P	164.00	148.00	137.00	125.00	101.00	82.00	69.50	50.70	33.60	
KM 185 P	190.00	171.00	158.00	144.00	116.00	95.00	80.00	58.70	38.90	
KM 205 P	210.00	190.00	175.00	160.00	129.00	105.00	89.00	65.00	43.10	
KM 225 P	221.00	200.00	184.00	169.00	136.00	115.00	98.00	69.80	47.30	
KM 250 P	246.00	222.00	205.00	187.00	151.00	128.00	109.00	77.60	52.60	
KM 270 P	266.00	240.00	221.00	202.00	163.00	138.00	117.00	83.80	56.80	
KM 300 P	312.00	281.00	260.00	232.00	188.00	165.00	133.00	93.80	63.00	
KM 320 P	332.00	299.00	277.00	248.00	200.00	176.00	142.00	100.00	67.20	
KM 340 P	353.00	318.00	295.00	263.00	213.00	187.00	151.00	106.00	71.40	
KM 355 P	369.00	332.00	308.00	275.00	222.00	196.00	157.00	111.00	74.60	
KM 380 P	395.00	356.00	329.00	294.00	238.00	209.00	169.00	119.00	79.80	
KM 400 P	405.00	365.00	338.00	302.00	244.00	215.00	173.00	125.00	84.00	
KM 420 P	425.00	383.00	355.00	317.00	256.00	226.00	182.00	131.00	88.00	
KM 450 P	443.00	400.00	369.00	337.00	272.00	238.00	203.00	149.00	94.50	
KM 470 P	463.00	418.00	385.00	352.00	284.00	249.00	212.00	156.00	99.00	
KM 500 P	492.00	444.00	410.00	374.00	302.00	264.00	226.00	166.00	105.00	
KM 520 P	512.00	462.00	426.00	389.00	314.00	275.00	235.00	172.00	109.00	
KM 550 P	541.00	489.00	451.00	412.00	332.00	291.00	248.00	182.00	116.00	
KM 570 P	561.00	507.00	467.00	427.00	344.00	302.00	257.00	189.00	120.00	
KM 600 P	591.00	533.00	492.00	449.00	363.00	317.00	271.00	199.00	126.00	
KM 630 P	621.00	560.00	517.00	471.00	381.00	333.00	285.00	209.00	132.00	
KM 675 P	665.00	600.00	554.00	506.00	408.00	357.00	305.00	224.00	142.00	
KM 705 P	695.00	627.00	579.00	528.00	426.00	373.00	319.00	234.00	148.00	
KM 750 P	738.00	667.00	615.00	562.00	453.00	397.00	338.00	248.00	158.00	
KM 850 P	836.00	756.00	697.00	637.00	513.00	450.00	383.00	281.00	179.00	
KM 950 P	935.00	845.00	779.00	712.00	574.00	503.00	428.00	314.00	200.00	
KM 1000 P	984.00	889.00	820.00	749.00	604.00	529.00	451.00	331.00	210.00	
KM 1050 P	1033.00	933.00	861.00	786.00	634.00	555.00	474.00	348.00	221.00	
KM 1150 P	1132.00	1022.00	943.00	861.00	695.00	608.00	519.00	381.00	242.00	
KM 1250 P	1231.00	1111.00	1025.00	936.00	756.00	661.00	564.00	414.00	263.00	
KM 1390 P	1369.00	1235.00	1140.00	1041.00	841.00	735.00	627.00	460.00	292.00	

Final discharge voltage per cell / Entladeschlussspannung pro Zelle

1.05 V

Cell type / Zelltyp										
	5 min	10 min	20 min	30 min	1 h	1.5 h	2 h	3 h	5 h	
KM 11 P	14.70	13.40	11.20	9.90	7.50	6.16	5.02	3.52	2.38	
KM 18 P	24.10	21.90	18.30	16.10	12.30	10.10	8.20	5.76	3.89	
KM 24 P	32.20	29.20	24.40	21.50	16.40	13.40	11.00	7.68	5.18	
KM 30 P	40.20	36.50	30.50	26.90	20.50	16.80	13.70	9.60	6.48	
KM 40 P	49.20	43.10	36.90	33.80	27.40	22.50	18.20	12.80	8.64	
KM 48 P	64.60	56.60	48.50	44.40	33.20	27.20	22.40	15.90	10.40	
KM 55 P	80.00	70.00	60.00	55.00	39.00	32.80	26.60	19.00	12.10	
KM 65 P	85.00	78.00	70.00	64.00	47.00	38.40	30.60	21.20	14.10	
KM 75 P	98.00	90.00	80.00	74.00	55.00	44.30	35.30	24.50	16.20	
KM 90 P	118.00	108.00	97.00	88.00	65.00	53.20	42.40	29.40	19.50	
KM 110 P	144.00	132.00	118.00	108.00	80.00	65.00	51.80	35.90	23.80	
KM 125 P	154.00	139.00	127.00	116.00	89.00	74.00	59.10	41.20	26.90	
KM 140 P	181.00	164.00	150.00	137.00	105.00	83.00	66.20	46.20	30.10	
KM 160 P	207.00	187.00	172.00	156.00	120.00	95.00	75.70	52.80	34.40	
KM 185 P	239.00	217.00	199.00	180.00	139.00	110.00	88.00	61.00	39.80	
KM 205 P	265.00	240.00	220.00	200.00	154.00	122.00	97.00	67.60	44.10	
KM 225 P	279.00	253.00	232.00	211.00	162.00	134.00	106.00	74.20	48.40	
KM 250 P	310.00	281.00	258.00	234.00	180.00	149.00	118.00	82.40	53.80	
KM 270 P	335.00	303.00	278.00	253.00	195.00	161.00	128.00	89.00	58.10	
KM 300 P	377.00	346.00	315.00	284.00	223.00	185.00	141.00	96.00	64.50	
KM 320 P	402.00	369.00	336.00	303.00	238.00	197.00	150.00	102.00	68.80	
KM 340 P	427.00	392.00	357.00	322.00	253.00	209.00	160.00	109.00	73.10	
KM 355 P	446.00	410.00	373.00	336.00	264.00	218.00	167.00	114.00	76.30	
KM 380 P	477.00	438.00	399.00	360.00	283.00	234.00	178.00	122.00	81.70	
KM 400 P	490.00	450.00	410.00	369.00	290.00	240.00	183.00	128.00	86.00	
KM 420 P	515.00	473.00	431.00	387.00	305.00	252.00	192.00	134.00	90.00	
KM 450 P	558.00	506.00	464.00	421.00	320.00	269.00	218.00	156.00	99.00	
KM 470 P	583.00	528.00	485.00	440.00	334.00	281.00	228.00	163.00	103.00	
KM 500 P	620.00	562.00	516.00	468.00	356.00	299.00	242.00	173.00	110.00	
KM 520 P	645.00	584.00	537.00	486.00	370.00	311.00	252.00	180.00	114.00	
KM 550 P	682.00	618.00	567.00	515.00	391.00	329.00	266.00	191.00	121.00	
KM 570 P	707.00	640.00	588.00	534.00	405.00	341.00	276.00	198.00	125.00	
KM 600 P	744.00	675.00	619.00	561.00	427.00	359.00	291.00	208.00	132.00	
KM 630 P	781.00	709.00	650.00	589.00	448.00	377.00	306.00	218.00	139.00	
KM 675 P	837.00	759.00	696.00	632.00	480.00	404.00	327.00	234.00	149.00	
KM 705 P	874.00	793.00	727.00	660.00	501.00	422.00	342.00	244.00	156.00	
KM 750 P	930.00	843.00	773.00	702.00	533.00	448.00	363.00	260.00	165.00	
KM 850 P	1054.00	955.00	876.00	796.00	604.00	508.00	411.00	295.00	187.00	
KM 950 P	1178.00	1068.00	979.00	889.00	675.00	567.00	460.00	329.00	209.00	
KM 1000 P	1240.00	1124.00	1031.00	936.00	711.00	598.00	484.00	347.00	220.00	
KM 1050 P	1302.00	1180.00	1083.00	983.00	747.00	628.00	508.00	364.00	231.00	
KM 1150 P	1426.00	1293.00	1186.00	1076.00	818.00	688.00	557.00	399.00	253.00	
KM 1250 P	1550.00	1406.00	1289.00	1169.00	889.00	747.00	606.00	433.00	275.00	
KM 1390 P	1724.00	1563.00	1433.00	1300.00	989.00	831.00	674.00	481.00	306.00	

Final discharge voltage per cell / Entladeschlussspannung pro Zelle

1.00 V

Cell type / Zelltyp										
	5 min	10 min	20 min	30 min	1 h	1.5 h	2 h	3 h	5 h	
KM 11 P	16.90	15.90	13.50	11.80	8.60	6.71	5.32	3.70	2.42	
KM 18 P	27.70	26.00	22.10	19.80	14.50	11.00	8.70	6.06	3.96	
KM 24 P	37.00	34.70	29.50	26.40	19.40	14.60	11.60	8.08	5.28	
KM 30 P	46.20	43.40	36.90	33.00	24.30	18.30	14.50	10.10	6.60	
KM 40 P	55.40	50.50	46.00	44.00	32.40	24.40	19.40	13.46	8.80	
KM 48 P	72.70	66.30	54.80	52.30	37.80	30.30	23.70	16.30	10.50	
KM 55 P	90.00	82.00	67.00	60.50	44.50	36.20	27.90	19.20	12.20	
KM 65 P	98.00	91.00	80.00	74.00	54.00	40.70	32.00	21.90	14.30	
KM 75 P	113.00	105.00	93.00	85.00	62.00	46.90	36.90	25.20	16.50	
KM 90 P	135.00	126.00	111.00	102.00	74.00	56.30	44.30	30.30	19.80	
KM 110 P	165.00	154.00	136.00	125.00	91.00	68.80	54.10	37.00	24.20	
KM 125 P	182.00	168.00	151.00	139.00	101.00	79.00	61.00	42.10	27.50	
KM 140 P	215.00	198.00	178.00	164.00	120.00	89.00	68.30	47.10	30.80	
KM 160 P	246.00	226.00	203.00	187.00	137.00	101.00	78.00	53.90	35.20	
KM 185 P	284.00	262.00	235.00	217.00	158.00	117.00	90.00	62.30	40.70	
KM 205 P	315.00	290.00	260.00	240.00	175.00	130.00	100.00	69.00	45.10	
KM 225 P	332.00	306.00	274.00	253.00	186.00	143.00	110.00	75.70	49.50	
KM 250 P	369.00	340.00	304.00	281.00	205.00	159.00	122.00	84.10	55.00	
KM 270 P	398.00	367.00	329.00	303.00	223.00	171.00	132.00	90.90	59.40	
KM 300 P	460.00	415.00	370.00	335.00	250.00	187.00	144.00	98.30	66.00	
KM 320 P	491.00	443.00	395.00	358.00	267.00	199.00	153.00	105.00	70.40	
KM 340 P	521.00	471.00	419.00	380.00	283.00	212.00	163.00	111.00	74.80	
KM 355 P	544.00	492.00	438.00	397.00	296.00	221.00	170.00	116.00	78.10	
KM 380 P	583.00	526.00	469.00	425.00	317.00	237.00	182.00	124.00	83.60	
KM 400 P	598.00	540.00	481.00	436.00	325.00	243.00	187.00	131.00	88.00	
KM 420 P	628.00	567.00	505.00	458.00	341.00	255.00	196.00	138.00	92.00	
KM 450 P	664.00	612.00	547.00	495.00	365.00	297.00	229.00	158.00	99.90	
KM 470 P	694.00	639.00	571.00	517.00	381.00	310.00	239.00	165.00	104.00	
KM 500 P	738.00	680.00	608.00	550.00	406.00	330.00	254.00	176.00	111.00	
KM 520 P	768.00	707.00	632.00	572.00	422.00	343.00	265.00	183.00	115.00	
KM 550 P	812.00	748.00	669.00	605.00	446.00	363.00	280.00	193.00	122.00	
KM 570 P	842.00	775.00	693.00	627.00	462.00	376.00	290.00	200.00	126.00	
KM 600 P	885.00	816.00	729.00	660.00	487.00	396.00	305.00	211.00	133.00	
KM 630 P	929.00	857.00	765.00	693.00	511.00	416.00	320.00	222.00	140.00	
KM 675 P	996.00	918.00	821.00	743.00	548.00	446.00	344.00	237.00	150.00	
KM 705 P	1040.00	959.00	857.00	776.00	572.00	466.00	359.00	248.00	157.00	
KM 750 P	1107.00	1020.00	912.00	825.00	608.00	495.00	382.00	263.00	167.00	
KM 850 P	1255.00	1156.00	1034.00	935.00	689.00	561.00	433.00	298.00	189.00	
KM 950 P	1402.00	1292.00	1155.00	1045.00	770.00	627.00	484.00	333.00	212.00	
KM 1000 P	1476.00	1360.00	1216.00	1100.00	811.00	660.00	509.00	351.00	222.00	
KM 1050 P	1550.00	1428.00	1277.00	1155.00	852.00	693.00	534.00	369.00	233.00	
KM 1150 P	1697.00	1564.00	1398.00	1265.00	933.00	759.00	585.00	404.00	255.00	
KM 1250 P	1844.00	1700.00	1519.00	1375.00	1014.00	825.00	636.00	439.00	278.00	
KM 1390 P	2051.00	1890.00	1689.00	1529.00	1128.00	917.00	707.00	488.00	309.00	

KH ... P Battery Range

Batteriebaureihe KH ... P

KH ... P Battery Range

This GAZ® H type was designed especially for high current discharging over short discharge periods. The recommended discharge time for this cell range is 1 s to 30 min.

Important Notice

The nominal capacity C_5 is not the basis for the performance of the batteries. Performance depends on the battery construction, i.e. on the different battery ranges. Therefore, our discharge tables should be used to find out the appropriated cell type for a specific application.

The nominal capacity C_5 of KH ... P range batteries is based on the available ampere hours (Ah) at a discharge rate of 5 hours to a final discharge voltage of 1.00 V per cell at $20\text{ °C} \pm 5\text{ °C}$.

Nominal voltage per cell is 1.2 V.

Discharging conditions

The discharge performances as well as the nominal capacities C_5 given in this brochure are only valid for fully charged cells in accordance with EN 60623/ IEC 60623.

Charging conditions KH ... P Battery Range

1. Constant voltage

Stand by

Float: 1.36 – 1.42 V/cell

Boost charge: 1.55 – 1.65 V/cell

Buffer operation

Average value: 1.55 – 1.60 V/cell

Current limitation: $0.5 I_t$ A

2. Constant current at 25 °C [A]

Standard charge: $0.2 I_t$ A for 7 – 8 h

Boost recharge: $0.5 I_t$ A for 2.5 h

followed by $0.2 I_t$ A for 2.5 h

Baureihe KH ... P

Ni-Cd Zellen dieser Baureihe sind speziell für Hochstromanwendungen mit kurzen Entladezeiten konstruiert. Die empfohlene Entladezeit für die KH ... P oder TSP Baureihe beträgt 1 s bis 30 min.

Wichtig

Die Nennkapazität C_5 ist keine Bemessungsgrundlage für die Leistung. Die Leistung hängt von der Batteriekonstruktion, bzw. von der Typenbaureihe ab. Deshalb sollten unsere Entladetabellen genutzt werden, um den entsprechenden Zellentyp für eine bestimmte Anwendung zu bestimmen.

Die Nennkapazität C_5 der KH ... P Baureihe basiert auf den entnehmbaren Amperestunden (Ah) bei fünfständiger Entladung und auf einer Entladeschlussspannung von 1,00 V pro Zelle bei $20\text{ °C} \pm 5\text{ °C}$.

Die Nennspannung pro Zelle beträgt 1,2 V.

Entladeverhalten

Die in unseren Tabellen angegebenen Entladewerte sowie die Nennkapazitäten beruhen auf ordnungsgemäß geladenen Zellen laut IEC 60623 und EN 60623.

Ladebedingungen Baureihe KH ... P

1. Konstantspannung

Bereitschaftsbetrieb

Erhaltungsladen: 1,36 – 1,42 V/Zelle

Starkladen: 1,55 – 1,65 V/Zelle

Pufferbetrieb

Mittelwert: 1,55 – 1,60 V/Zelle

Strombegrenzung: $0,5 I_t$ A

2. Konstantstrom bei 25 °C [A]

Standardladung: $0,2 I_t$ A während 7 – 8 h

Starkladung: $0,5 I_t$ A während 2,5 h

dann $0,2 I_t$ A während 2,5 h

Battery Layout

KH 10 P – KH 20 P

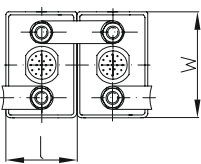

KH 30 P – KH 125 P (M 8)

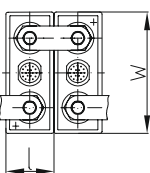

KH 150 P (M 8)

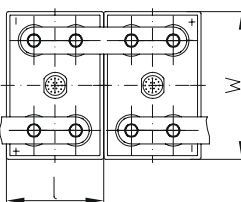

KH 185 P – KH 250 P (M 8)

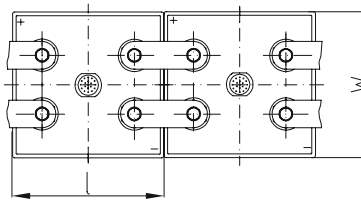

KH 280 P – KH 320 P (M 10)

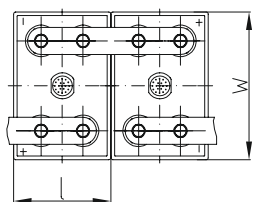

KH 360 P – KH 480 P (M 10)

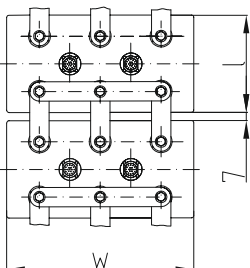

KH 520 P – KH 640 P (M 10)

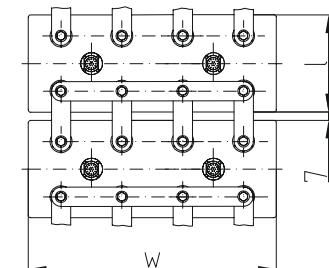

KH 700 P – KH 800 P (M 10)

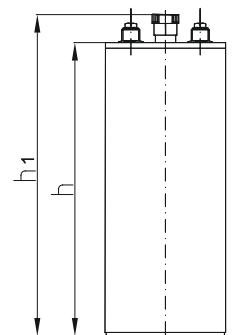
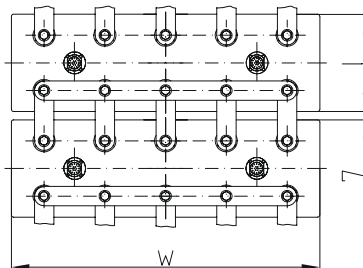

Technical Specifications / Technische Kenndaten

Cell type Zelltyp	Nominal Capacity C ₅ [Ah] at 1.00 V Nennkapazität C ₅ [Ah] bei 1,00 V	Dimensions / Abmessungen [mm]				Terminals / Pole		Weight / Gewicht [kg]	
		l	w	h	h ₁	Type / Art M = Nut / Mutter S = Screw / Schraube	Size / Größe	without Electrolyte / ohne Elektrolyt	Total Weight / Gesamtgewicht
KH 10 P	10	46,0	85	237	261	M	2 x M 10	1.1	1.6
KH 20 P	20	46,0	85	237	261	M	2 x M 10	1.6	1.9
KH 30 P	30	53,0	134	330	360	S	2 x M 8	2.7	4.1
KH 40 P	40	53,0	134	330	360	S	2 x M 8	3.1	4.4
KH 50 P	50	53,0	134	330	360	S	2 x M 8	3.6	4.6
KH 65 P	65	69,0	134	330	360	S	2 x M 8	4.5	6.1
KH 80 P	80	69,0	134	330	360	S	2 x M 8	5.4	6.6
KH 100 P	100	103,5	134	330	360	S	2 x M 8	6.5	8.8
KH 125 P	125	103,5	134	330	360	S	2 x M 8	7.8	9.7
KH 150 P	150	108,0	164	330	360	S	4 x M 8	8.9	11.9
KH 185 P	185	164,0	158	330	360	S	4 x M 8	10.6	15.6
KH 200 P	200	164,0	158	330	360	S	4 x M 8	11.4	16.2
KH 235 P	235	164,0	158	330	360	S	4 x M 8	12.6	17.1
KH 250 P	250	164,0	158	330	360	S	4 x M 8	13.0	17.4
KH 280 P	280	176,0	246	330	360	S	4 x M 10	17.0	23.7
KH 300 P	300	176,0	246	330	360	S	4 x M 10	17.7	24.2
KH 320 P	320	176,0	246	330	360	S	4 x M 10	18.5	24.6
KH 360 P	360	176,0	368	330	360	S	6 x M 10	22.7	33.9
KH 390 P	390	176,0	368	330	360	S	6 x M 10	23.8	34.7
KH 420 P	420	176,0	368	330	360	S	6 x M 10	24.8	35.4
KH 450 P	450	176,0	368	330	360	S	6 x M 10	26.0	36.3
KH 480 P	480	176,0	368	330	360	S	6 x M 10	27.1	37.0
KH 520 P	520	176,0	448	330	360	S	8 x M 10	31.5	44.7
KH 560 P	560	176,0	448	330	360	S	8 x M 10	33.0	45.9
KH 600 P	600	176,0	448	330	360	S	8 x M 10	34.5	47.0
KH 640 P	640	176,0	448	330	360	S	8 x M 10	36.0	48.1
KH 700 P	700	176,0	558	330	360	S	10 x M 10	41.1	57.2
KH 750 P	750	176,0	558	330	360	S	10 x M 10	43.0	58.6
KH 800 P	800	176,0	558	330	360	S	10 x M 10	44.9	60.0

Final discharge voltage per cell / Entladeschlussspannung pro Zelle

1.15 V

Cell type/Zelltyp	1 s	5 s	10 s	30 s	1 min	5 min	10 min	15 min	30 min	60 min	90 min
KH 10 P	53.80	43.80	40.00	33.80	30.00	20.00	17.00	15.00	11.30	7.50	6.00
KH 20 P	107.50	87.50	80.00	67.50	60.00	40.00	34.00	30.00	22.50	15.00	12.00
KH 30 P	161.30	131.30	120.00	101.30	90.00	60.00	51.00	45.00	33.80	22.50	18.00
KH 40 P	215.00	175.00	160.00	135.00	120.00	80.00	68.00	60.00	45.00	30.00	24.00
KH 50 P	243.00	206.30	189.40	165.60	146.90	103.10	87.50	81.30	60.00	40.80	28.90
KH 65 P	316.90	268.10	246.20	215.30	190.90	134.10	113.80	105.60	78.00	53.00	37.60
KH 80 P	390.00	330.00	303.00	265.00	235.00	165.00	140.00	130.00	96.00	65.20	46.30
KH 100 P	432.00	360.00	336.00	292.00	256.00	184.00	160.00	140.00	108.00	72.00	56.00
KH 125 P	540.00	450.00	420.00	365.00	320.00	230.00	200.00	175.00	135.00	90.00	70.00
KH 150 P	576.00	499.00	466.00	405.00	357.00	259.00	219.00	191.00	150.00	114.00	84.00
KH 185 P	710.00	615.00	575.00	500.00	440.00	320.00	270.00	235.00	185.00	141.00	104.00
KH 200 P	752.00	656.00	616.00	528.00	468.00	344.00	296.00	260.00	212.00	152.00	112.00
KH 235 P	884.00	771.00	724.00	620.00	550.00	404.00	348.00	306.00	249.00	179.00	132.00
KH 250 P	940.00	820.00	770.00	660.00	585.00	430.00	370.00	326.00	265.00	190.00	140.00
KH 280 P	1075.00	931.00	870.00	756.00	666.00	483.00	409.00	357.00	280.00	213.00	157.00
KH 300 P	1152.00	998.00	932.00	810.00	714.00	518.00	438.00	382.00	300.00	228.00	168.00
KH 320 P	1229.00	1065.00	994.00	864.00	762.00	553.00	467.00	407.00	320.00	243.00	179.00
KH 360 P	1382.00	1198.00	1118.00	972.00	857.00	622.00	526.00	458.00	360.00	274.00	202.00
KH 390 P	1498.00	1297.00	1212.00	1053.00	928.00	673.00	569.00	497.00	390.00	296.00	218.00
KH 420 P	1613.00	1397.00	1305.00	1134.00	1000.00	725.00	613.00	535.00	420.00	319.00	235.00
KH 450 P	1728.00	1497.00	1398.00	1215.00	1071.00	777.00	657.00	573.00	450.00	342.00	252.00
KH 480 P	1843.00	1597.00	1491.00	1296.00	1142.00	829.00	701.00	611.00	480.00	365.00	269.00
KH 520 P	1997.00	1730.00	1615.00	1404.00	1238.00	898.00	759.00	662.00	520.00	395.00	291.00
KH 560 P	2150.00	1863.00	1740.00	1512.00	1333.00	967.00	818.00	713.00	560.00	426.00	314.00
KH 600 P	2304.00	1996.00	1864.00	1620.00	1428.00	1036.00	876.00	764.00	600.00	456.00	336.00
KH 640 P	2458.00	2129.00	1988.00	1728.00	1523.00	1105.00	934.00	815.00	640.00	486.00	358.00
KH 700 P	2688.00	2329.00	2175.00	1890.00	1666.00	1209.00	1022.00	891.00	700.00	532.00	392.00
KH 750 P	2880.00	2495.00	2330.00	2025.00	1785.00	1295.00	1095.00	955.00	750.00	570.00	420.00
KH 800 P	3072.00	2661.00	2485.00	2160.00	1904.00	1381.00	1168.00	1019.00	800.00	608.00	448.00

Final discharge voltage per cell / Entladeschlussspannung pro Zelle

1.10 V

Cell type/Zelltyp	1 s	5 s	10 s	30 s	1 min	5 min	10 min	15 min	30 min	60 min	90 min
KH 10 P	66.30	56.30	51.30	43.00	38.80	27.50	22.50	20.00	15.00	9.00	6.30
KH 20 P	132.50	112.50	102.50	86.00	77.50	55.00	45.00	40.00	30.00	18.00	12.70
KH 30 P	198.80	168.80	153.80	129.00	116.30	82.50	67.50	60.00	45.00	27.00	19.00
KH 40 P	265.00	225.00	205.00	172.00	155.00	110.00	90.00	80.00	60.00	36.00	25.30
KH 50 P	300.00	265.60	243.80	209.40	187.50	137.50	115.60	106.30	76.30	48.10	32.30
KH 65 P	390.00	345.30	316.90	272.20	243.80	178.80	150.30	138.10	99.10	62.60	42.00
KH 80 P	480.00	425.00	390.00	335.00	300.00	220.00	185.00	170.00	122.00	77.00	51.70
KH 100 P	548.00	464.00	424.00	368.00	328.00	240.00	204.00	184.00	144.00	96.00	64.80
KH 125 P	685.00	580.00	530.00	460.00	410.00	300.00	255.00	230.00	180.00	120.00	81.00
KH 150 P	742.00	645.00	596.00	511.00	454.00	324.00	276.00	239.00	186.00	132.00	89.40
KH 185 P	915.00	795.00	735.00	630.00	560.00	400.00	340.00	295.00	230.00	163.00	110.00
KH 200 P	928.00	805.00	744.00	656.00	596.00	440.00	364.00	316.00	256.00	176.00	119.00
KH 235 P	1090.00	946.00	874.00	771.00	700.00	517.00	427.00	371.00	301.00	207.00	140.00
KH 250 P	1160.00	1006.00	930.00	820.00	745.00	570.00	454.00	395.00	320.00	220.00	149.00
KH 280 P	1385.00	1204.00	1113.00	954.00	847.00	605.00	515.00	446.00	347.00	246.00	167.00
KH 300 P	1484.00	1290.00	1192.00	1022.00	908.00	648.00	552.00	478.00	372.00	264.00	179.00
KH 320 P	1583.00	1376.00	1271.00	1090.00	969.00	691.00	589.00	510.00	397.00	282.00	191.00
KH 360 P	1781.00	1548.00	1430.00	1226.00	1090.00	778.00	662.00	574.00	446.00	317.00	215.00
KH 390 P	1929.00	1677.00	1550.00	1329.00	1180.00	842.00	718.00	621.00	484.00	343.00	232.00
KH 420 P	2078.00	1806.00	1669.00	1431.00	1271.00	907.00	773.00	669.00	521.00	370.00	250.00
KH 450 P	2226.00	1935.00	1788.00	1533.00	1362.00	972.00	828.00	717.00	558.00	396.00	268.00
KH 480 P	2374.00	2064.00	1907.00	1635.00	1453.00	1037.00	883.00	765.00	595.00	422.00	286.00
KH 520 P	2572.00	2236.00	2066.00	1771.00	1574.00	1123.00	957.00	829.00	645.00	458.00	310.00
KH 560 P	2770.00	2408.00	2225.00	1908.00	1695.00	1210.00	1030.00	892.00	694.00	493.00	334.00
KH 600 P	2968.00	2580.00	2384.00	2044.00	1816.00	1296.00	1104.00	956.00	744.00	528.00	358.00
KH 640 P	3166.00	2752.00	2543.00	2180.00	1937.00	1382.00	1178.00	1020.00	794.00	563.00	381.00
KH 700 P	3463.00	3010.00	2781.00	2385.00	2119.00	1512.00	1288.00	1115.00	868.00	616.00	417.00
KH 750 P	3710.00	3225.00	2980.00	2555.00	2270.00	1620.00	1380.00	1195.00	930.00	660.00	447.00
KH 800 P	3957.00	3440.00	3179.00	2725.00	2421.00	1728.00	1472.00	1275.00	992.00	704.00	477.00

Final discharge voltage per cell / Entladeschlussspannung pro Zelle

1.05 V

Cell type/Zelltyp	1 s	5 s	10 s	30 s	1 min	5 min	10 min	15 min	30 min	60 min	90 min
KH 10 P	78.80	66.30	62.50	52.50	46.30	33.80	26.30	23.80	17.50	9.40	6.50
KH 20 P	155.50	132.50	125.00	105.00	92.50	67.50	52.50	47.50	35.00	18.80	13.00
KH 30 P	236.30	198.80	187.50	157.50	138.80	101.30	78.80	71.30	52.50	28.10	19.50
KH 40 P	315.00	265.00	250.00	210.00	185.00	135.00	105.00	95.00	70.00	37.50	26.00
KH 50 P	350.00	309.40	287.50	250.00	231.30	168.60	138.80	121.90	84.40	49.10	33.10
KH 65 P	455.00	402.00	373.80	325.00	300.60	219.40	180.40	158.40	109.70	63.80	43.10
KH 80 P	560.00	495.00	460.00	400.00	370.00	270.00	222.00	195.00	135.00	78.50	53.00
KH 100 P	640.00	540.00	496.00	432.00	396.00	304.00	252.00	220.00	164.00	98.40	66.20
KH 125 P	800.00	675.00	620.00	540.00	495.00	380.00	315.00	275.00	205.00	123.00	82.70
KH 150 P	908.00	758.00	701.00	612.00	551.00	405.00	341.00	308.00	243.00	135.00	90.60
KH 185 P	1120.00	935.00	865.00	755.00	680.00	500.00	420.00	380.00	300.00	167.00	112.00
KH 200 P	1130.00	950.00	875.00	768.00	696.00	536.00	452.00	428.00	304.00	180.00	121.00
KH 235 P	1328.00	1117.00	1028.00	902.00	818.00	630.00	531.00	503.00	357.00	212.00	142.00
KH 250 P	1413.00	1188.00	1094.00	960.00	870.00	670.00	565.00	535.00	380.00	226.00	151.00
KH 280 P	1695.00	1415.00	1309.00	1142.00	1029.00	756.00	637.00	575.00	454.00	252.00	169.00
KH 300 P	1816.00	1516.00	1402.00	1224.00	1102.00	810.00	682.00	616.00	486.00	270.00	181.00
KH 320 P	1937.00	1617.00	1495.00	1306.00	1175.00	864.00	727.00	657.00	518.00	288.00	193.00
KH 360 P	2179.00	1819.00	1682.00	1469.00	1322.00	972.00	818.00	739.00	583.00	324.00	217.00
KH 390 P	2361.00	1971.00	1823.00	1591.00	1433.00	1053.00	887.00	801.00	632.00	351.00	236.00
KH 420 P	2542.00	2122.00	1963.00	1714.00	1543.00	1134.00	955.00	862.00	680.00	378.00	254.00
KH 450 P	2724.00	2274.00	2103.00	1836.00	1653.00	1215.00	1023.00	924.00	729.00	405.00	272.00
KH 480 P	2906.00	2426.00	2243.00	1958.00	1763.00	1296.00	1091.00	986.00	778.00	432.00	290.00
KH 520 P	3148.00	2628.00	2430.00	2122.00	1910.00	1404.00	1182.00	1068.00	842.00	468.00	314.00
KH 560 P	3390.00	2830.00	2617.00	2285.00	2057.00	1512.00	1273.00	1150.00	907.00	504.00	338.00
KH 600 P	3632.00	3032.00	2804.00	2448.00	2204.00	1620.00	1364.00	1232.00	972.00	540.00	362.00
KH 640 P	3874.00										

Final discharge voltage per cell / Entladeschlussspannung pro Zelle

1.00 V

Cell type/Zelltyp	1 s	5 s	10 s	30 s	1 min	5 min	10 min	15 min	30 min	60 min	90 min
KH 10 P	92.50	78.80	71.30	61.30	55.00	40.00	31.30	27.50	18.50	9.50	6.60
KH 20 P	185.00	157.50	142.50	122.50	110.10	80.00	62.50	55.00	37.00	19.00	13.20
KH 30 P	277.50	236.30	213.80	183.80	165.00	120.00	93.80	82.50	55.50	28.50	19.80
KH 40 P	370.00	315.00	285.00	245.00	220.00	160.00	125.00	110.00	74.00	38.00	26.40
KH 50 P	409.40	362.50	334.40	290.60	268.80	196.90	159.40	134.40	87.50	50.00	33.50
KH 65 P	532.20	471.30	434.70	377.80	349.40	255.90	207.20	174.70	113.80	65.00	43.60
KH 80 P	665.00	580.00	535.00	465.00	430.00	315.00	255.00	215.00	140.00	80.00	53.60
KH 100 P	704.00	604.00	560.00	496.00	452.00	344.00	300.00	256.00	176.00	100.00	67.20
KH 125 P	880.00	755.00	700.00	620.00	565.00	430.00	375.00	320.00	220.00	125.00	84.00
KH 150 P	1038.00	892.00	835.00	714.00	641.00	454.00	381.00	336.00	258.00	138.00	92.40
KH 185 P	1280.00	1100.00	1030.00	880.00	790.00	560.00	470.00	415.00	318.00	170.00	114.00
KH 200 P	1288.00	1120.00	1040.00	910.00	840.00	648.00	560.00	500.00	344.00	184.00	123.00
KH 235 P	1513.00	1316.00	1222.00	1070.00	987.00	761.00	658.00	588.00	404.00	216.00	145.00
KH 250 P	1610.00	1400.00	1300.00	1138.00	1050.00	810.00	700.00	626.00	430.00	230.00	154.00
KH 280 P	1938.00	1665.00	1559.00	1333.00	1197.00	847.00	711.00	640.00	482.00	258.00	172.00
KH 300 P	2076.00	1784.00	1670.00	1428.00	1282.00	908.00	762.00	672.00	516.00	276.00	185.00
KH 320 P	2214.00	1903.00	1781.00	1523.00	1367.00	969.00	813.00	717.00	550.00	294.00	197.00
KH 360 P	2491.00	2141.00	2004.00	1714.00	1538.00	1090.00	914.00	806.00	619.00	331.00	222.00
KH 390 P	2699.00	2319.00	2171.00	1856.00	1667.00	1180.00	991.00	874.00	671.00	359.00	240.00
KH 420 P	2906.00	2498.00	2338.00	1999.00	1795.00	1271.00	1067.00	941.00	722.00	386.00	259.00
KH 450 P	3114.00	2676.00	2505.00	2142.00	1923.00	1362.00	1143.00	1008.00	774.00	414.00	277.00
KH 480 P	3322.00	2854.00	2672.00	2285.00	2051.00	1453.00	1219.00	1075.00	826.00	442.00	296.00
KH 520 P	3598.00	3092.00	2895.00	2475.00	2222.00	1574.00	1321.00	1165.00	894.00	478.00	320.00
KH 560 P	3875.00	3330.00	3117.00	2666.00	2393.00	1695.00	1422.00	1254.00	963.00	515.00	345.00
KH 600 P	4152.00	3568.00	3340.00	2856.00	2564.00	1816.00	1524.00	1344.00	1032.00	552.00	370.00
KH 640 P	4429.00	3806.00	3563.00	3046.00	2735.00	1937.00	1626.00	1434.00	1101.00	589.00	394.00
KH 700 P	4844.00	4163.00	3897.00	3332.00	2991.00	2119.00	1778.00	1568.00	1204.00	644.00	431.00
KH 750 P	5190.00	4460.00	4175.00	3570.00	3205.00	2270.00	1905.00	1680.00	1290.00	690.00	462.00
KH 800 P	5536.00	4757.00	4453.00	3808.00	3419.00	2421.00	2032.00	1792.00	1376.00	736.00	493.00

Final discharge voltage per cell / Entladeschlussspannung pro Zelle

0.85 V

Cell type/Zelltyp	1 s	5 s	10 s	30 s	1 min	5 min	10 min	15 min	30 min	60 min	90 min
KH 10 P	127.50	110.00	100.00	91.30	82.50	60.00	43.80	33.80	19.30	9.80	6.70
KH 20 P	255.00	220.00	200.00	182.50	165.00	120.00	87.50	67.50	38.50	19.50	13.30
KH 30 P	382.50	330.00	300.00	273.80	247.50	180.00	131.30	101.30	57.80	29.30	20.00
KH 40 P	510.00	440.00	400.00	365.00	330.00	240.00	175.00	135.00	77.00	39.00	26.60
KH 50 P	556.30	490.60	456.30	409.40	375.00	284.40	215.60	156.30	90.60	50.60	33.90
KH 65 P	723.10	637.80	593.10	532.20	487.50	369.70	280.30	203.10	117.80	65.80	44.10
KH 80 P	890.00	785.00	730.00	655.00	600.00	455.00	345.00	250.00	145.00	81.00	54.30
KH 100 P	1020.00	880.00	816.00	720.00	660.00	496.00	392.00	320.00	188.00	101.60	68.20
KH 125 P	1275.00	1100.00	1020.00	900.00	825.00	620.00	490.00	400.00	235.00	127.00	85.30
KH 150 P	1378.00	1208.00	1119.00	981.00	908.00	689.00	559.00	442.00	276.00	140.00	94.20
KH 185 P	1700.00	1490.00	1380.00	1210.00	1120.00	850.00	690.00	545.00	340.00	172.00	116.00
KH 200 P	1738.00	1530.00	1419.00	1240.00	1144.00	936.00	800.00	616.00	368.00	186.00	126.00
KH 235 P	2010.00	1763.00	1634.00	1457.00	1344.00	1100.00	940.00	724.00	432.00	219.00	148.00
KH 250 P	2138.00	1876.00	1738.00	1550.00	1430.00	1170.00	1000.00	770.00	460.00	233.00	157.00
KH 280 P	2572.00	2255.00	2089.00	1831.00	1695.00	1286.00	1043.00	825.00	515.00	261.00	176.00
KH 300 P	2756.00	2416.00	2238.00	1962.00	1816.00	1378.00	1118.00	884.00	552.00	280.00	188.00
KH 320 P	2940.00	2577.00	2387.00	2093.00	1937.00	1470.00	1193.00	943.00	589.00	299.00	201.00
KH 360 P	3307.00	2899.00	2686.00	2354.00	2179.00	1654.00	1342.00	1061.00	662.00	336.00	226.00
KH 390 P	3583.00	3141.00	2909.00	2551.00	2361.00	1791.00	1453.00	1149.00	718.00	364.00	245.00
KH 420 P	3858.00	3382.00	3133.00	2747.00	2542.00	1929.00	1565.00	1238.00	773.00	392.00	264.00
KH 450 P	4134.00	3624.00	3357.00	2943.00	2724.00	2067.00	1677.00	1326.00	828.00	420.00	283.00
KH 480 P	4410.00	3866.00	3581.00	3139.00	2906.00	2205.00	1789.00	1414.00	883.00	448.00	301.00
KH 520 P	4777.00	4188.00	3879.00	3401.00	3148.00	2389.00	1938.00	1532.00	957.00	485.00	327.00
KH 560 P	5145.00	4510.00	4178.00	3662.00	3390.00	2572.00	2087.00	1650.00	1030.00	523.00	352.00
KH 600 P	5512.00	4832.00	4476.00	3924.00	3632.00	2756.00	2236.00	1768.00	1104.00	560.00	377.00
KH 640 P	5879.00	5154.00	4774.00	4186.00	3874.00	2940.00	2385.00	1886.00	1178.00	597.00	402.00
KH 700 P	6431.00	5637.00	5222.00	4578.00	4237.00	3215.00	2609.00	2063.00	1288.00	653.00	441.00
KH 750 P	6890.00	6040.00	5595.00	4905.00	4540.00	3445.00	2795.00	2210.00	1380.00	700.00	470.00
KH 800 P	7349.00	6443.00	5968.00	5232.00	4843.00	3675.00	2981.00	2357.00	1472.00	747.00	502.00

Final discharge voltage per cell / Entladeschlussspannung pro Zelle

0.65 V

Cell type/Zelltyp	1 s	5 s	10 s	30 s	1 min	5 min	10 min	15 min	30 min	60 min	90 min
KH 10 P	165.00	145.00	138.80	126.30	115.00	75.00	50.00	36.30	20.00	10.10	6.80
KH 20 P	330.00	290.00	277.50	252.50	230.00	150.00	100.00	72.50	40.00	20.30	13.70
KH 30 P	495.00	435.00	416.30	378.80	345.00	225.00	150.00	108.80	60.00	30.40	20.50
KH 40 P	660.00	580.00	555.00	505.00	460.00	300.00	200.00	145.00	80.00	40.50	27.30
KH 50 P	753.10	665.60	631.30	575.00	531.30	359.40	237.50	168.80	93.80	51.30	34.40
KH 65 P	979.10	865.30	820.60	747.50	690.60	467.20	308.80	219.40	121.90	66.60	44.70
KH 80 P	1205.00	1065.00	1010.00	920.00	850.00	575.00	380.00	270.00	150.00	82.00	55.00
KH 100 P	1360.00	1200.00	1136.00	1016.00	920.00	652.00	476.00	350.00	196.00	103.20	69.30
KH 125 P	1700.00	1500.00	1388.00	1215.00	1105.00	815.00	595.00	460.00	245.00	129.00	86.60
KH 150 P	1808.00	1557.00	1435.00	1265.00	1151.00	876.00	641.00	442.00	281.00	141.00	94.80
KH 185 P	2201.00	1890.00	1740.00	1560.00	1420.00	1070.00	790.00	570.00	346.00	174.00	117.00
KH 200 P	2240.00	1928.00	1780.00	1586.00	1446.00	1106.00	912.00	696.00	374.00	188.00	126.00
KH 235 P	2632.00	2265.00	2092.00	1863.00	1699.00	1299.00	1072.00	800.00	440.00	221.00	149.00
KH 250 P	2800.00	2410.00	2226.00	1982.00	1807.00	1382.00	1140.00	771.00	468.00	235.00	159.00
KH 280 P	3375.00	2906.00	2679.00	2361.00	2149.00	1635.00	1197.00	862.00	525.00	263.00	177.00
KH 300 P	3616.00	3114.00	2870.00	2530.00	2302.00	1752.00	1282.00	924.00	562.00	282.00	190.00
KH 320 P	3857.00	3322.00	3061.00	2699.00	2455.00	1869.00	1367.00	986.00	599.00	301.00	202.00
KH 360 P	4339.00	3737.00	3444.00	3036.00	2762.00	2102.00	1538.00	1109.00	674.00	338.00	228.00
KH 390 P	4701.00	4048.00	3731.00	3289.00	2993.00	2278.00	1667.00	1201.00	731.00	367.00	246.00
KH 420 P	5062.00	4360.00	4018.00	3542.00	3223.00	2453.00	1795.00	1294.00	787.00	395.00	265.00
KH 450 P	5424.00	4671.00	4305.00	3795.00	3453.00	2628.00	1923.00	1386.00	843.00	423.00	284.00
KH 480 P	5786.00	4982.00	4592.00	4048.00	3683.00	2803.00	2051.00	1478.00	899.00	451.00	303.00
KH 520 P	6268.00	5398.00	4975.00	4385.00	3990.00	3037.00	2222.00	1602.00	974.00	489.00	329.00
KH 560 P	6750.00	5813.00	5357.00	4723.00	4297.00	3270.00	2393.00	1725			

All dimensions and weights stated are subject to usual manufacturing tolerances. Electrical values are approximate. The right is reserved to make any alterations without prior notice.

Alle Maß- und Gewichtsangaben unterliegen herkömmlichen Fertigungstoleranzen. Die elektrischen Werte sind angenähert. Änderungen sind ohne Anzeigepflicht vorbehalten.



...the opportunity to have the choice

An ENERSYS Company

GAZ Geräte- und Akkumulatorenwerk Zwickau GmbH
 Reichenbacher Str. 62-68 | 08056 Zwickau | Germany
 Tel.: +49-375-86-0 | Fax: +49-375-86-440 | e-mail: sales@gaz-gmbh.com

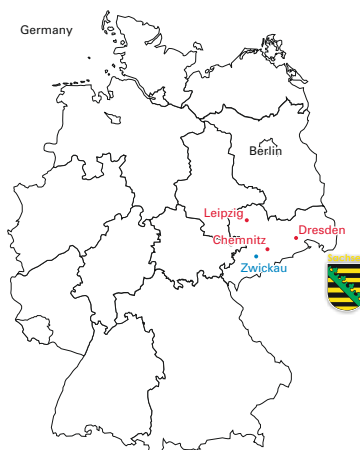

www.gaz-gmbh.com

**EnerSys
 North America
 South America**

2366 Bernville Road – USA
 Reading, PA 19605
 Phone: +1 610-208-1991
 Fax: +1 610-372-8457

**EnerSys – (EMEA)
 Europe – Middle East – Africa**

EH Europe GmbH
 Löwenstrasse 32
 8001 Zürich – Switzerland
 Phone: +41 44 215 74 10
 Fax: +41 44 215 74 11

EnerSys Asia Oceania

152 Beach Road
 Gateway East Building
 #11-03
 Singapore 189721
 Phone: +65 6508 1780
 Fax: +65 6292 4380

Contact: